

A forum for woodworkers of all skill levels to share their common interests

NORTHWEST WOODWORKERS' GUILD

THE SAWDUST NEWS

May 2011

<http://www.nwwguild.org>

Next Meeting:

Metal Inlay

**By John
Shrader**

**Thursday
May 26, 2011**

▶ 6:30 PM ◀

**Woodcraft Supply
5963 Corson Ave. S.
Seattle, WA 98108**

Guild Officers

President—Bob Schaefer
**Vice-president and
Membership**—Sally Wright
Treasurer—Chris Green
Secretary—Rick Tydings
Programs—Al Falco, Don
McNutt, Jack Martin, Ed
Moore, Ray Ross
Raffle—Tom Murray, Herb
Stoops

The following are volunteer
positions and are not
Officers of the Guild:

Webmaster
Tom Howorth
thoworth@gmail.com

Newsletter
Steve Krauss
catbert@oz.net
425-746-5067

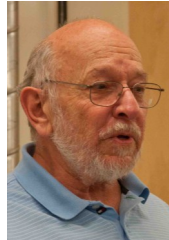

President's Message

— by Bob Schaefer

The April 28 meeting was truly outstanding. Michael Dresdner put on a most informative question and answer program responding to numerous questions with wit, humor and, most importantly, great depth and breadth of knowledge of wood finishing. He also demonstrated many examples of different types of finishes on different woods plus additional items to illustrate the points he was making. A truly memorable presentation by a master in the field.

Short business notes. Three thousand dollars in the treasury and eighty eight paid members.

The next meeting is May 26 at 6:30 PM at Woodcraft Supply. The speaker will be John Shrader who will talk about doing metal inlay in wood. I have spoken with Mr. Shrader and visited his website (crestcreations.net) and I am sure this will also be a fine program. Be sure to check out the website.

Thanks again to Don McNutt and George Knutson for their able assistance, and to Ray Ross for bringing the goodies. And again much gratitude to Ron Hall for letting the Guild have its meetings in this great venue.

We will also have a Raffle and Show-and-tell at the next meeting! Be sure to bring your recent projects to share, and your \$\$ to purchase raffle tickets.



A forum for woodworkers of all skill levels to share their common interests

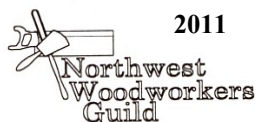

Northwest Woodworkers Guild
Steve Krauss, Newsletter Editor
16204 Main St
Bellevue, WA 98008

Member's Discounts

All members in good standing receive a membership card that will allow them to get a discount at the stores listed below:

Crosscut Hardwoods
4100—1st Avenue S.,
Seattle 98134
10% Discount

Rockler Woodworking
3823 Stone Way N.
Seattle 98103
10% Discount (not valid on power tools)

Woodcraft Supply
5963 Corson S.,
Seattle 98108
10% Discount (not valid on power tools or workbenches)

Edensaw Woods
8032 S. 194th St.
Kent, WA 98032

Please present your current membership card to receive your discount.

Shop Tip (submitted by Herb Stoops)

DRILL BITS PROVIDE GREAT MEASUREMENT

When setting the distance from a router bit to the fence on your router table, a drill bit often can provide you with a more accurate measurement than any ruler in your shop. For example, when you need a $\frac{1}{4}$ " space, simply hold the shank of a $\frac{1}{4}$ " twist-type drill bit against the router bit, as shown at *right*, and move the fence in until the drill bit fits snug against both surfaces.

Don't, however, push the fence in so tight that you can't remove the drill bit. Rather, adjust the fence until the drill bit drags lightly on both the router bit and the fence when you withdraw it (much like using a spark-plug feeler gauge).

You also can employ this technique for setting the height of a router bit. Place a straightedge across the top of the bit, as shown at *right*, and adjust the height of the router bit until the drill bit fits snugly between the router base or tabletop and the straightedge.

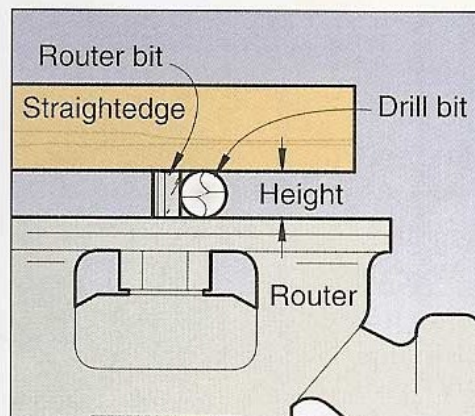
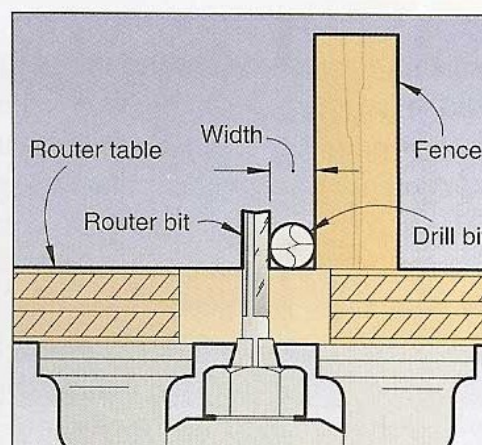

—Ed John, South Sioux City, Ne

April Meeting



April Meeting

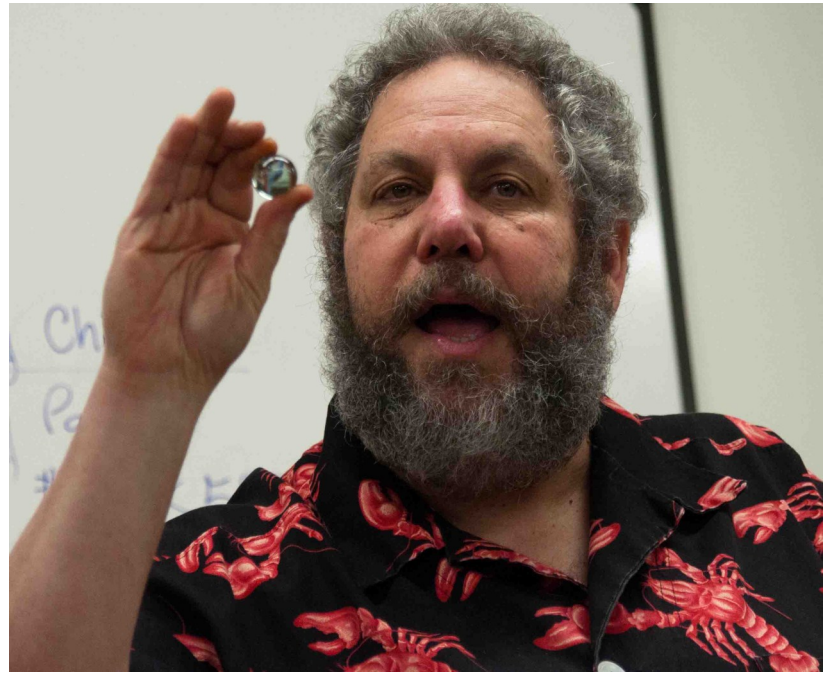
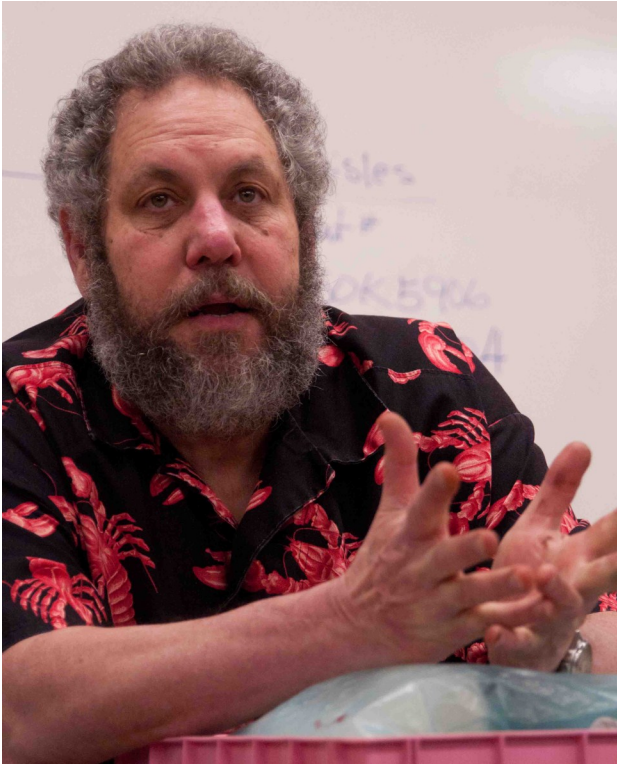

April Meeting



April Meeting



A forum for woodworkers of all skill levels to share their common interests

NORTHWEST WOODWORKERS' GUILD

THE SAWDUST NEWS

May 2011

<http://www.nwwguild.org>

Next Meeting:

Metal Inlay

**By John
Shrader**

**Thursday
May 26, 2011**

▶ 6:30 PM ◀

**Woodcraft Supply
5963 Corson Ave. S.
Seattle, WA 98108**

Guild Officers

President—Bob Schaefer
**Vice-president and
Membership**—Sally Wright
Treasurer—Chris Green
Secretary—Rick Tydings
Programs—Al Falco, Don
McNutt, Jack Martin, Ed
Moore, Ray Ross
Raffle—Tom Murray, Herb
Stoops

The following are volunteer
positions and are not
Officers of the Guild:

Webmaster
Tom Howorth
thoworth@gmail.com

Newsletter
Steve Krauss
catbert@oz.net
425-746-5067



President's Message

— by Bob Schaefer

The April 28 meeting was truly outstanding. Michael Dresdner put on a most informative question and answer program responding to numerous questions with wit, humor and, most importantly, great depth and breadth of knowledge of wood finishing. He also demonstrated many examples of different types of finishes on different woods plus additional items to illustrate the points he was making. A truly memorable presentation by a master in the field.

Short business notes. Three thousand dollars in the treasury and eighty eight paid members.

The next meeting is May 26 at 6:30 PM at Woodcraft Supply. The speaker will be John Shrader who will talk about doing metal inlay in wood. I have spoken with Mr. Shrader and visited his website (crestcreations.net) and I am sure this will also be a fine program. Be sure to check out the website.

Thanks again to Don McNutt and George Knutson for their able assistance, and to Ray Ross for bringing the goodies. And again much gratitude to Ron Hall for letting the Guild have its meetings in this great venue.

We will also have a Raffle and Show-and-tell at the next meeting! Be sure to bring your recent projects to share, and your \$\$ to purchase raffle tickets.



A forum for woodworkers of all skill levels to share their common interests

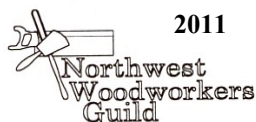

Northwest Woodworkers Guild
Steve Krauss, Newsletter Editor
16204 Main St
Bellevue, WA 98008

Member's Discounts

All members in good standing receive a membership card that will allow them to get a discount at the stores listed below:

Crosscut Hardwoods
4100—1st Avenue S.,
Seattle 98134
10% Discount

Rockler Woodworking
3823 Stone Way N.
Seattle 98103
10% Discount (not valid on power tools)

Woodcraft Supply
5963 Corson S.,
Seattle 98108
10% Discount (not valid on power tools or workbenches)

Edensaw Woods
8032 S. 194th St.
Kent, WA 98032

Please present your current membership card to receive your discount.

Shop Tip (submitted by Herb Stoops)

DRILL BITS PROVIDE GREAT MEASUREMENT

When setting the distance from a router bit to the fence on your router table, a drill bit often can provide you with a more accurate measurement than any ruler in your shop. For example, when you need a $\frac{1}{4}$ " space, simply hold the shank of a $\frac{1}{4}$ " twist-type drill bit against the router bit, as shown at *right*, and move the fence in until the drill bit fits snug against both surfaces.

Don't, however, push the fence in so tight that you can't remove the drill bit. Rather, adjust the fence until the drill bit drags lightly on both the router bit and the fence when you withdraw it (much like using a spark-plug feeler gauge).

You also can employ this technique for setting the height of a router bit. Place a straightedge across the top of the bit, as shown at *right*, and adjust the height of the router bit until the drill bit fits snugly between the router base or tabletop and the straightedge.

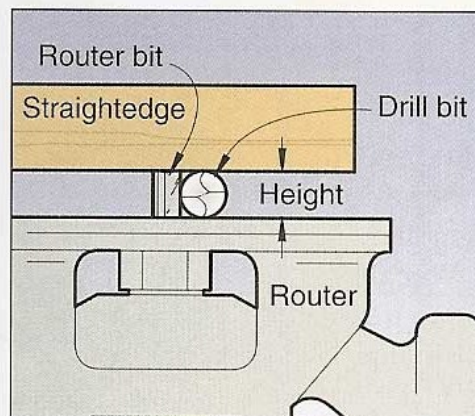
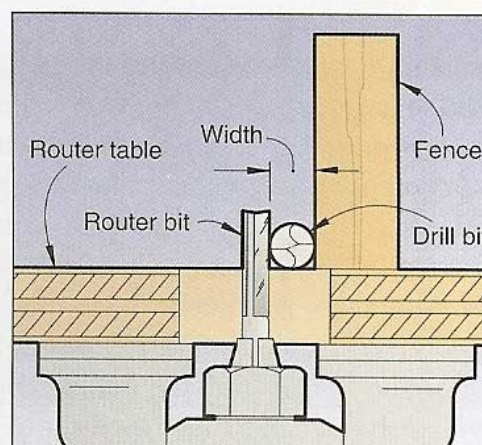

—Ed John, South Sioux City, Ne

April Meeting



April Meeting

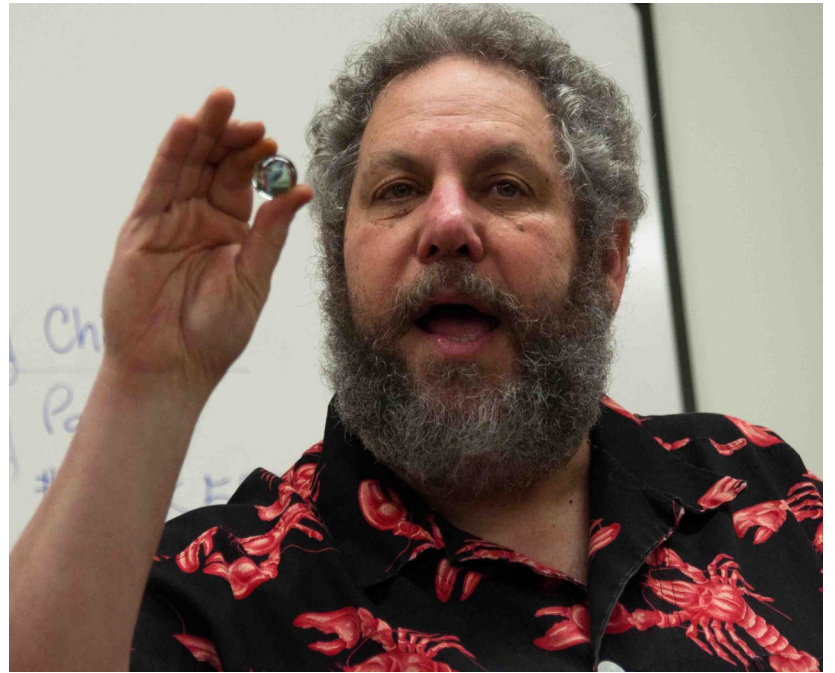
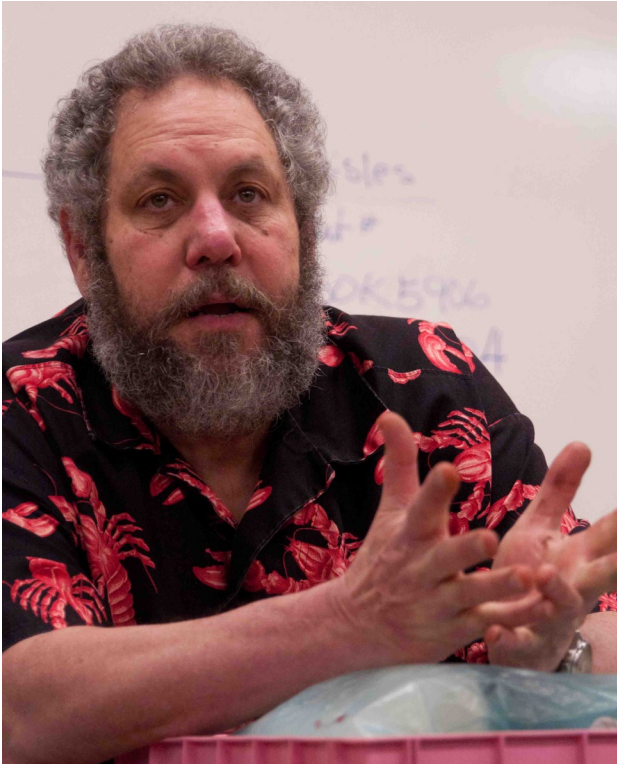

April Meeting



April Meeting



A forum for woodworkers of all skill levels to share their common interests

NORTHWEST WOODWORKERS' GUILD

THE SAWDUST NEWS

May 2011

<http://www.nwwguild.org>

Next Meeting:

Metal Inlay

**By John
Shrader**

**Thursday
May 26, 2011**

► 6:30 PM ◄

**Woodcraft Supply
5963 Corson Ave. S.
Seattle, WA 98108**

Guild Officers

President—Bob Schaefer
**Vice-president and
Membership**—Sally Wright
Treasurer—Chris Green
Secretary—Rick Tydings
Programs—Al Falco, Don
McNutt, Jack Martin, Ed
Moore, Ray Ross
Raffle—Tom Murray, Herb
Stoops

The following are volunteer
positions and are not
Officers of the Guild:

Webmaster
Tom Howorth
thoworth@gmail.com

Newsletter
Steve Krauss
catbert@oz.net
425-746-5067

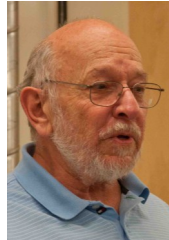

President's Message

— by Bob Schaefer

The April 28 meeting was truly outstanding. Michael Dresdner put on a most informative question and answer program responding to numerous questions with wit, humor and, most importantly, great depth and breadth of knowledge of wood finishing. He also demonstrated many examples of different types of finishes on different woods plus additional items to illustrate the points he was making. A truly memorable presentation by a master in the field.

Short business notes. Three thousand dollars in the treasury and eighty eight paid members.

The next meeting is May 26 at 6:30 PM at Woodcraft Supply. The speaker will be John Shrader who will talk about doing metal inlay in wood. I have spoken with Mr. Shrader and visited his website (crestcreations.net) and I am sure this will also be a fine program. Be sure to check out the website.

Thanks again to Don McNutt and George Knutson for their able assistance, and to Ray Ross for bringing the goodies. And again much gratitude to Ron Hall for letting the Guild have its meetings in this great venue.

We will also have a Raffle and Show-and-tell at the next meeting! Be sure to bring your recent projects to share, and your \$\$ to purchase raffle tickets.



A forum for woodworkers of all skill levels to share their common interests

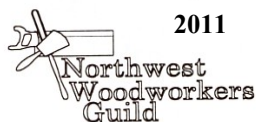

Northwest Woodworkers Guild
Steve Krauss, Newsletter Editor
16204 Main St
Bellevue, WA 98008

Member's Discounts

All members in good standing receive a membership card that will allow them to get a discount at the stores listed below:

Crosscut Hardwoods
4100—1st Avenue S.,
Seattle 98134
10% Discount

Rockler Woodworking
3823 Stone Way N.
Seattle 98103
10% Discount (not valid on power tools)

Woodcraft Supply
5963 Corson S.,
Seattle 98108
10% Discount (not valid on power tools or workbenches)

Edensaw Woods
8032 S. 194th St.
Kent, WA 98032

Please present your current membership card to receive your discount.

Shop Tip (submitted by Herb Stoops)

DRILL BITS PROVIDE GREAT MEASUREMENT

When setting the distance from a router bit to the fence on your router table, a drill bit often can provide you with a more accurate measurement than any ruler in your shop. For example, when you need a $\frac{1}{4}$ " space, simply hold the shank of a $\frac{1}{4}$ " twist-type drill bit against the router bit, as shown at *right*, and move the fence in until the drill bit fits snug against both surfaces.

Don't, however, push the fence in so tight that you can't remove the drill bit. Rather, adjust the fence until the drill bit drags lightly on both the router bit and the fence when you withdraw it (much like using a spark-plug feeler gauge).

You also can employ this technique for setting the height of a router bit. Place a straightedge across the top of the bit, as shown at *right*, and adjust the height of the router bit until the drill bit fits snugly between the router base or tabletop and the straightedge.

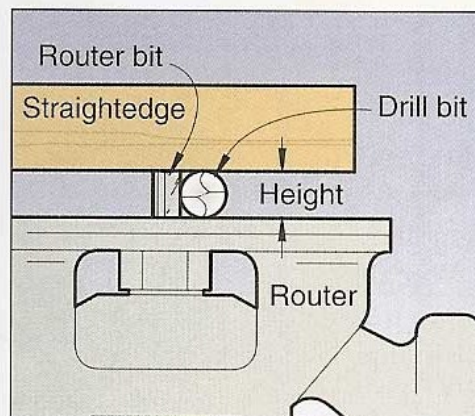
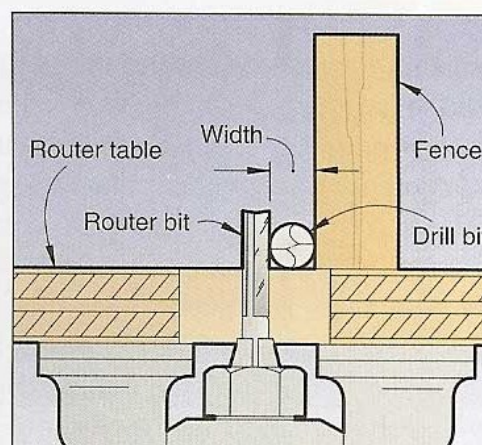

—Ed John, South Sioux City, Ne

April Meeting



April Meeting

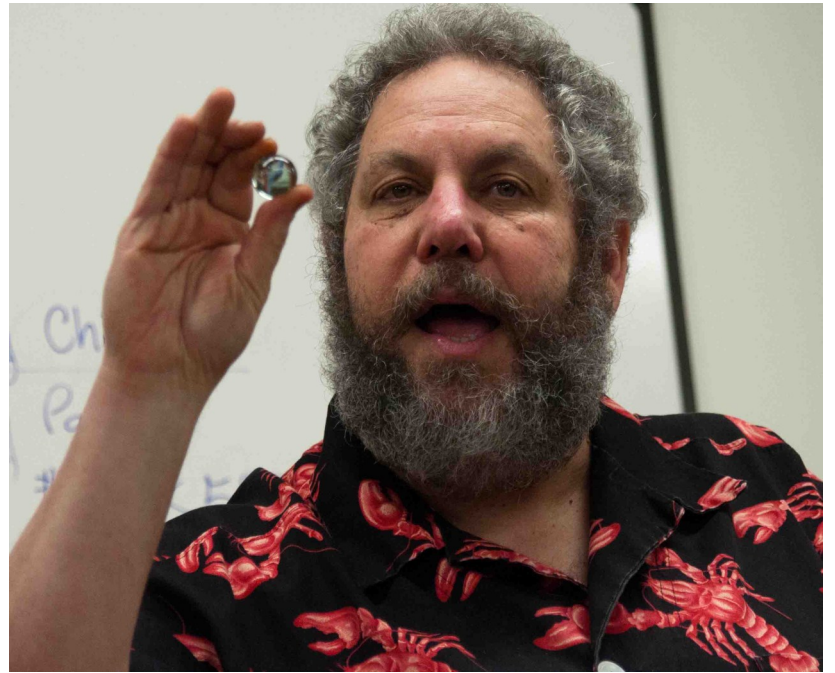
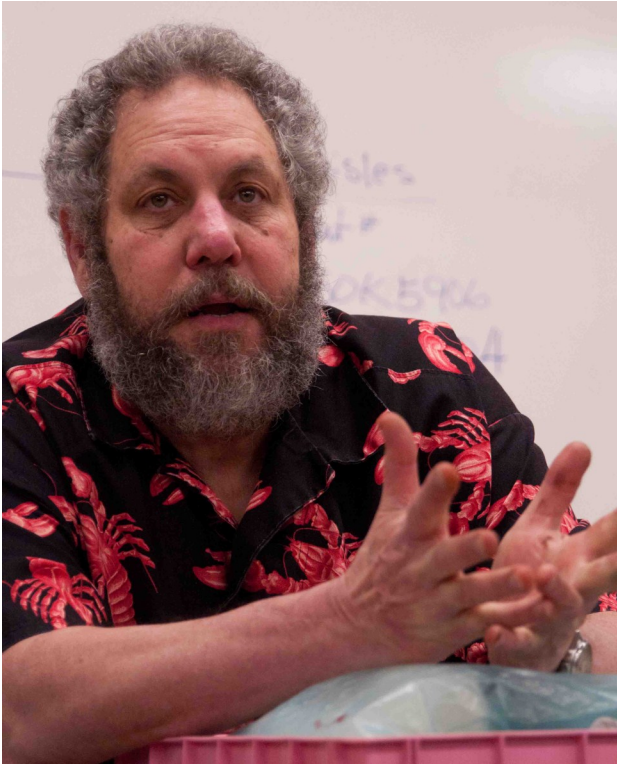

April Meeting



April Meeting



A forum for woodworkers of all skill levels to share their common interests

NORTHWEST WOODWORKERS' GUILD

THE SAWDUST NEWS

May 2011

<http://www.nwwguild.org>

Next Meeting:

Metal Inlay

**By John
Shrader**

**Thursday
May 26, 2011**

► 6:30 PM ◄

**Woodcraft Supply
5963 Corson Ave. S.
Seattle, WA 98108**

Guild Officers

President—Bob Schaefer
**Vice-president and
Membership**—Sally Wright
Treasurer—Chris Green
Secretary—Rick Tydings
Programs—Al Falco, Don
McNutt, Jack Martin, Ed
Moore, Ray Ross
Raffle—Tom Murray, Herb
Stoops

The following are volunteer
positions and are not
Officers of the Guild:

Webmaster
Tom Howorth
thoworth@gmail.com

Newsletter
Steve Krauss
catbert@oz.net
425-746-5067

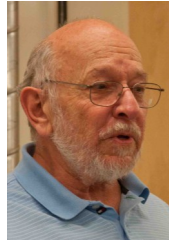

President's Message

— by Bob Schaefer

The April 28 meeting was truly outstanding. Michael Dresdner put on a most informative question and answer program responding to numerous questions with wit, humor and, most importantly, great depth and breadth of knowledge of wood finishing. He also demonstrated many examples of different types of finishes on different woods plus additional items to illustrate the points he was making. A truly memorable presentation by a master in the field.

Short business notes. Three thousand dollars in the treasury and eighty eight paid members.

The next meeting is May 26 at 6:30 PM at Woodcraft Supply. The speaker will be John Shrader who will talk about doing metal inlay in wood. I have spoken with Mr. Shrader and visited his website (crestcreations.net) and I am sure this will also be a fine program. Be sure to check out the website.

Thanks again to Don McNutt and George Knutson for their able assistance, and to Ray Ross for bringing the goodies. And again much gratitude to Ron Hall for letting the Guild have its meetings in this great venue.

We will also have a Raffle and Show-and-tell at the next meeting! Be sure to bring your recent projects to share, and your \$\$ to purchase raffle tickets.



A forum for woodworkers of all skill levels to share their common interests

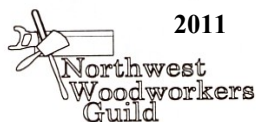

Northwest Woodworkers Guild
Steve Krauss, Newsletter Editor
16204 Main St
Bellevue, WA 98008

Member's Discounts

All members in good standing receive a membership card that will allow them to get a discount at the stores listed below:

Crosscut Hardwoods
4100—1st Avenue S.,
Seattle 98134
10% Discount

Rockler Woodworking
3823 Stone Way N.
Seattle 98103
10% Discount (not valid on power tools)

Woodcraft Supply
5963 Corson S.,
Seattle 98108
10% Discount (not valid on power tools or workbenches)

Edensaw Woods
8032 S. 194th St.
Kent, WA 98032

Please present your current membership card to receive your discount.

Shop Tip (submitted by Herb Stoops)

DRILL BITS PROVIDE GREAT MEASUREMENT

When setting the distance from a router bit to the fence on your router table, a drill bit often can provide you with a more accurate measurement than any ruler in your shop. For example, when you need a $\frac{1}{4}$ " space, simply hold the shank of a $\frac{1}{4}$ " twist-type drill bit against the router bit, as shown at *right*, and move the fence in until the drill bit fits snug against both surfaces.

Don't, however, push the fence in so tight that you can't remove the drill bit. Rather, adjust the fence until the drill bit drags lightly on both the router bit and the fence when you withdraw it (much like using a spark-plug feeler gauge).

You also can employ this technique for setting the height of a router bit. Place a straightedge across the top of the bit, as shown at *right*, and adjust the height of the router bit until the drill bit fits snugly between the router base or tabletop and the straightedge.

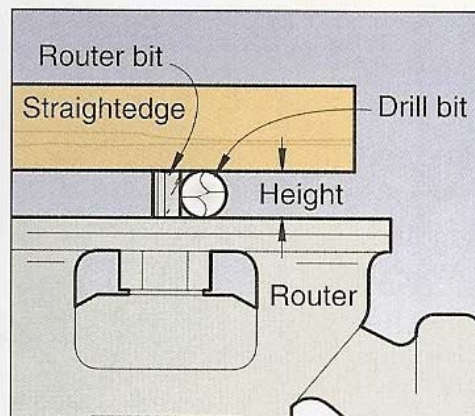
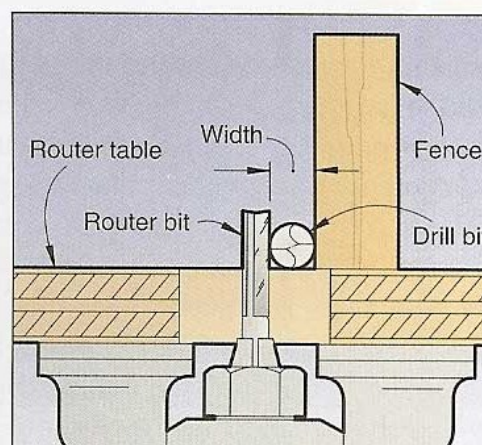

—Ed John, South Sioux City, Ne

April Meeting



April Meeting

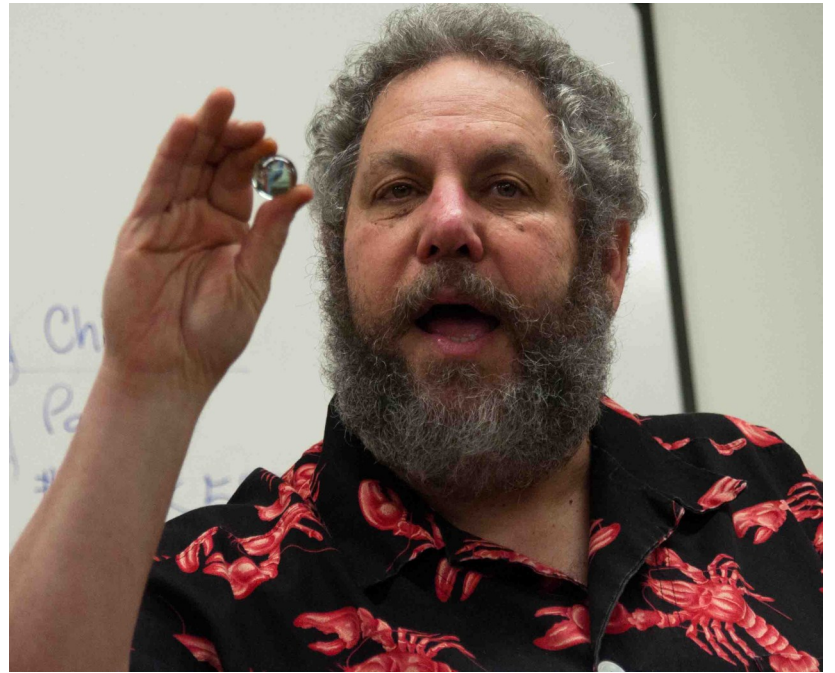
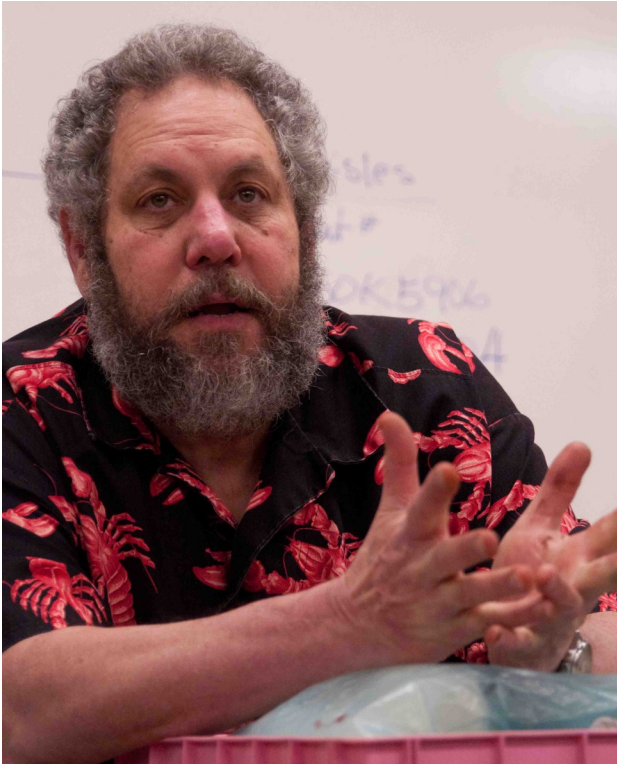

April Meeting



April Meeting



A forum for woodworkers of all skill levels to share their common interests

NORTHWEST WOODWORKERS' GUILD

THE SAWDUST NEWS

May 2011

<http://www.nwwguild.org>

Next Meeting:

Metal Inlay

**By John
Shrader**

**Thursday
May 26, 2011**

► 6:30 PM ◄

**Woodcraft Supply
5963 Corson Ave. S.
Seattle, WA 98108**

Guild Officers

President—Bob Schaefer
**Vice-president and
Membership**—Sally Wright
Treasurer—Chris Green
Secretary—Rick Tydings
Programs—Al Falco, Don
McNutt, Jack Martin, Ed
Moore, Ray Ross
Raffle—Tom Murray, Herb
Stoops

The following are volunteer
positions and are not
Officers of the Guild:

Webmaster
Tom Howorth
thoworth@gmail.com

Newsletter
Steve Krauss
catbert@oz.net
425-746-5067

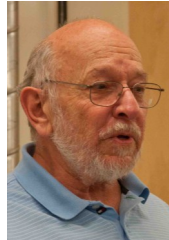

President's Message

— by Bob Schaefer

The April 28 meeting was truly outstanding. Michael Dresdner put on a most informative question and answer program responding to numerous questions with wit, humor and, most importantly, great depth and breadth of knowledge of wood finishing. He also demonstrated many examples of different types of finishes on different woods plus additional items to illustrate the points he was making. A truly memorable presentation by a master in the field.

Short business notes. Three thousand dollars in the treasury and eighty eight paid members.

The next meeting is May 26 at 6:30 PM at Woodcraft Supply. The speaker will be John Shrader who will talk about doing metal inlay in wood. I have spoken with Mr. Shrader and visited his website (crestcreations.net) and I am sure this will also be a fine program. Be sure to check out the website.

Thanks again to Don McNutt and George Knutson for their able assistance, and to Ray Ross for bringing the goodies. And again much gratitude to Ron Hall for letting the Guild have its meetings in this great venue.

We will also have a Raffle and Show-and-tell at the next meeting! Be sure to bring your recent projects to share, and your \$\$ to purchase raffle tickets.



A forum for woodworkers of all skill levels to share their common interests

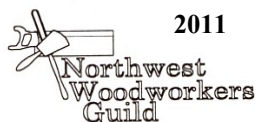

Northwest Woodworkers Guild
Steve Krauss, Newsletter Editor
16204 Main St
Bellevue, WA 98008

Member's Discounts

All members in good standing receive a membership card that will allow them to get a discount at the stores listed below:

Crosscut Hardwoods
4100—1st Avenue S.,
Seattle 98134
10% Discount

Rockler Woodworking
3823 Stone Way N.
Seattle 98103
10% Discount (not valid on power tools)

Woodcraft Supply
5963 Corson S.,
Seattle 98108
10% Discount (not valid on power tools or workbenches)

Edensaw Woods
8032 S. 194th St.
Kent, WA 98032

Please present your current membership card to receive your discount.

Shop Tip (submitted by Herb Stoops)

DRILL BITS PROVIDE GREAT MEASUREMENT

When setting the distance from a router bit to the fence on your router table, a drill bit often can provide you with a more accurate measurement than any ruler in your shop. For example, when you need a $\frac{1}{4}$ " space, simply hold the shank of a $\frac{1}{4}$ " twist-type drill bit against the router bit, as shown at *right*, and move the fence in until the drill bit fits snug against both surfaces.

Don't, however, push the fence in so tight that you can't remove the drill bit. Rather, adjust the fence until the drill bit drags lightly on both the router bit and the fence when you withdraw it (much like using a spark-plug feeler gauge).

You also can employ this technique for setting the height of a router bit. Place a straightedge across the top of the bit, as shown at *right*, and adjust the height of the router bit until the drill bit fits snugly between the router base or tabletop and the straightedge.

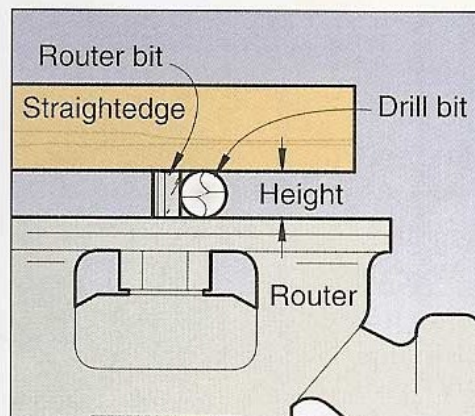
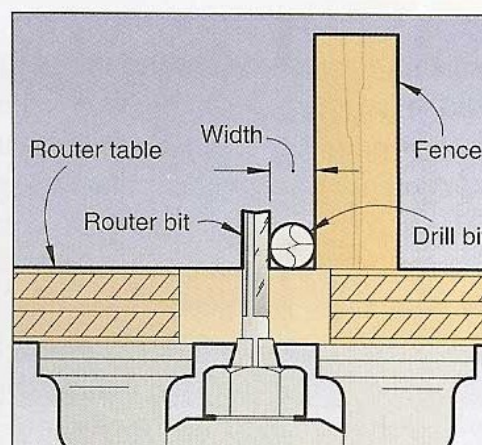

—Ed John, South Sioux City, Ne

April Meeting



April Meeting

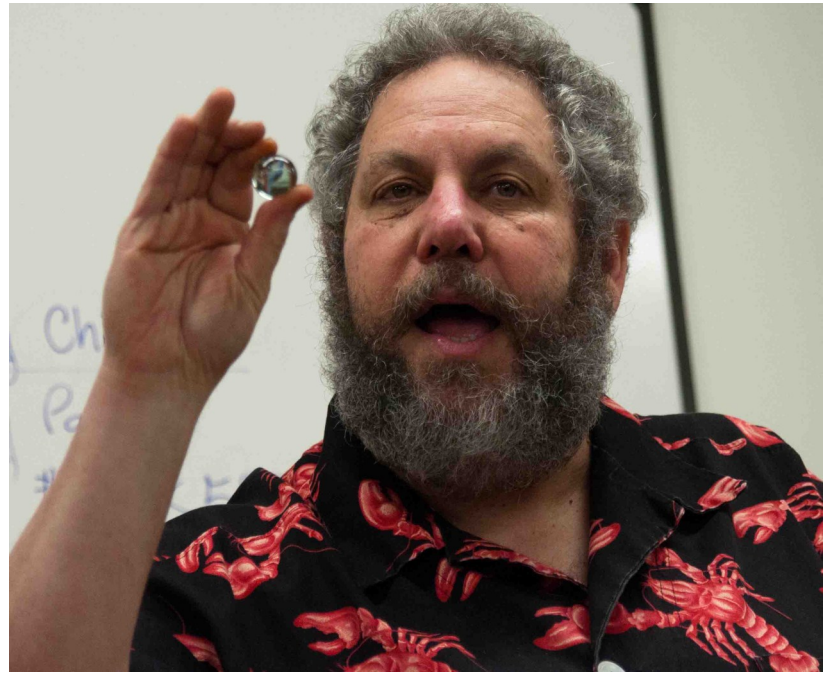
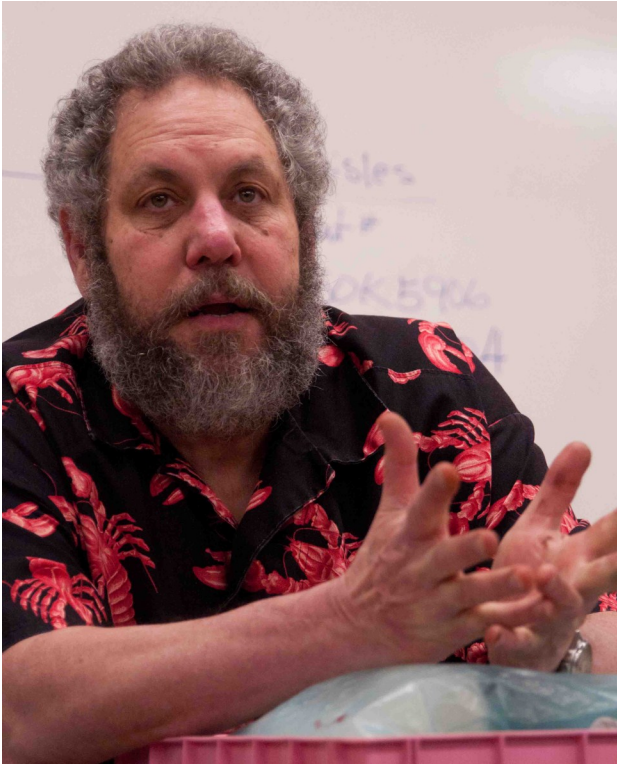

April Meeting



April Meeting



A forum for woodworkers of all skill levels to share their common interests

NORTHWEST WOODWORKERS' GUILD

THE SAWDUST NEWS

May 2011

<http://www.nwwguild.org>

Next Meeting:

Metal Inlay

**By John
Shrader**

**Thursday
May 26, 2011**

► 6:30 PM ◄

**Woodcraft Supply
5963 Corson Ave. S.
Seattle, WA 98108**

Guild Officers

President—Bob Schaefer
**Vice-president and
Membership**—Sally Wright
Treasurer—Chris Green
Secretary—Rick Tydings
Programs—Al Falco, Don
McNutt, Jack Martin, Ed
Moore, Ray Ross
Raffle—Tom Murray, Herb
Stoops

The following are volunteer
positions and are not
Officers of the Guild:

Webmaster
Tom Howorth
thoworth@gmail.com

Newsletter
Steve Krauss
catbert@oz.net
425-746-5067

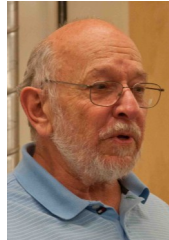

President's Message

— by Bob Schaefer

The April 28 meeting was truly outstanding. Michael Dresdner put on a most informative question and answer program responding to numerous questions with wit, humor and, most importantly, great depth and breadth of knowledge of wood finishing. He also demonstrated many examples of different types of finishes on different woods plus additional items to illustrate the points he was making. A truly memorable presentation by a master in the field.

Short business notes. Three thousand dollars in the treasury and eighty eight paid members.

The next meeting is May 26 at 6:30 PM at Woodcraft Supply. The speaker will be John Shrader who will talk about doing metal inlay in wood. I have spoken with Mr. Shrader and visited his website (crestcreations.net) and I am sure this will also be a fine program. Be sure to check out the website.

Thanks again to Don McNutt and George Knutson for their able assistance, and to Ray Ross for bringing the goodies. And again much gratitude to Ron Hall for letting the Guild have its meetings in this great venue.

We will also have a Raffle and Show-and-tell at the next meeting! Be sure to bring your recent projects to share, and your \$\$ to purchase raffle tickets.



A forum for woodworkers of all skill levels to share their common interests

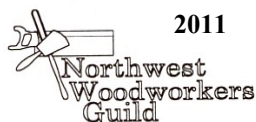

Northwest Woodworkers Guild
Steve Krauss, Newsletter Editor
16204 Main St
Bellevue, WA 98008

Member's Discounts

All members in good standing receive a membership card that will allow them to get a discount at the stores listed below:

Crosscut Hardwoods
4100—1st Avenue S.,
Seattle 98134
10% Discount

Rockler Woodworking
3823 Stone Way N.
Seattle 98103
10% Discount (not valid on power tools)

Woodcraft Supply
5963 Corson S.,
Seattle 98108
10% Discount (not valid on power tools or workbenches)

Edensaw Woods
8032 S. 194th St.
Kent, WA 98032

Please present your current membership card to receive your discount.

Shop Tip (submitted by Herb Stoops)

DRILL BITS PROVIDE GREAT MEASUREMENT

When setting the distance from a router bit to the fence on your router table, a drill bit often can provide you with a more accurate measurement than any ruler in your shop. For example, when you need a $\frac{1}{4}$ " space, simply hold the shank of a $\frac{1}{4}$ " twist-type drill bit against the router bit, as shown at *right*, and move the fence in until the drill bit fits snug against both surfaces.

Don't, however, push the fence in so tight that you can't remove the drill bit. Rather, adjust the fence until the drill bit drags lightly on both the router bit and the fence when you withdraw it (much like using a spark-plug feeler gauge).

You also can employ this technique for setting the height of a router bit. Place a straightedge across the top of the bit, as shown at *right*, and adjust the height of the router bit until the drill bit fits snugly between the router base or tabletop and the straightedge.

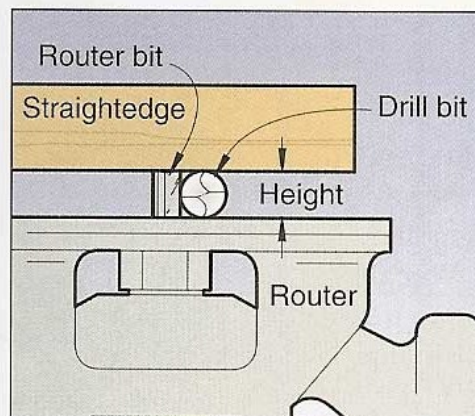
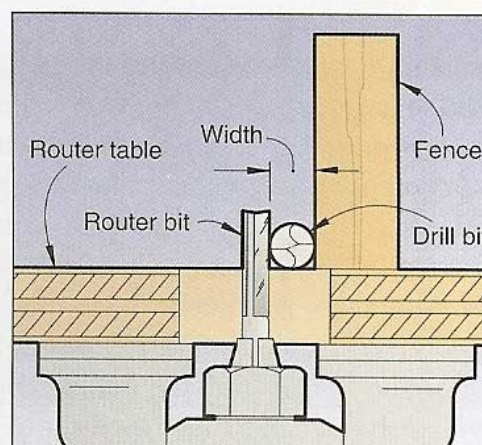

—Ed John, South Sioux City, Ne

April Meeting



April Meeting

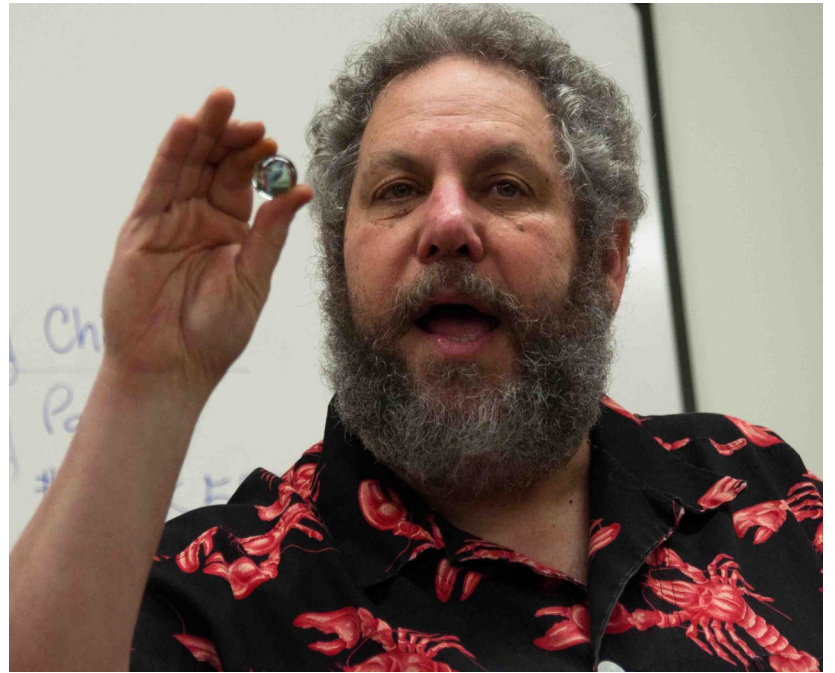
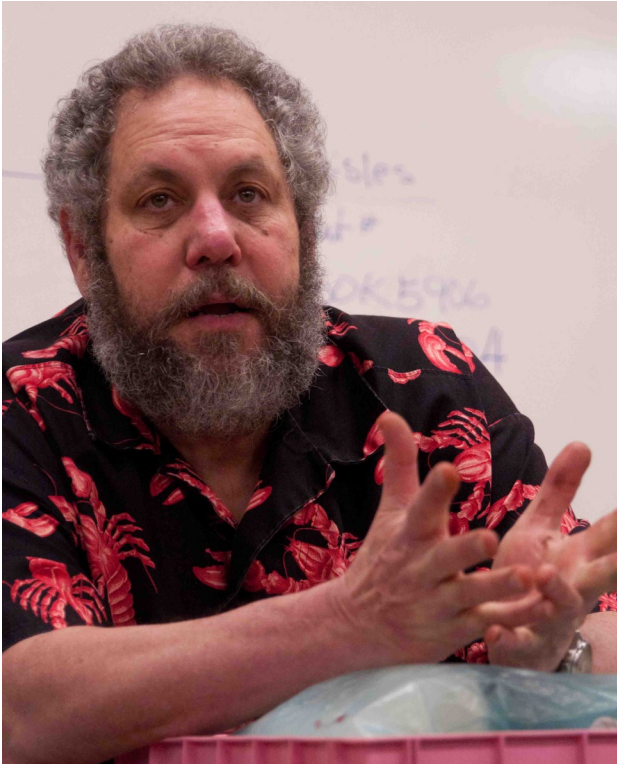

April Meeting



April Meeting



A forum for woodworkers of all skill levels to share their common interests

NORTHWEST WOODWORKERS' GUILD

THE SAWDUST NEWS

May 2011

<http://www.nwwguild.org>

Next Meeting:

Metal Inlay

**By John
Shrader**

**Thursday
May 26, 2011**

► 6:30 PM ◄

**Woodcraft Supply
5963 Corson Ave. S.
Seattle, WA 98108**

Guild Officers

President—Bob Schaefer
**Vice-president and
Membership**—Sally Wright
Treasurer—Chris Green
Secretary—Rick Tydings
Programs—Al Falco, Don
McNutt, Jack Martin, Ed
Moore, Ray Ross
Raffle—Tom Murray, Herb
Stoops

The following are volunteer
positions and are not
Officers of the Guild:

Webmaster
Tom Howorth
thoworth@gmail.com

Newsletter
Steve Krauss
catbert@oz.net
425-746-5067

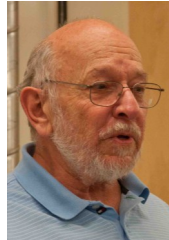

President's Message

— by Bob Schaefer

The April 28 meeting was truly outstanding. Michael Dresdner put on a most informative question and answer program responding to numerous questions with wit, humor and, most importantly, great depth and breadth of knowledge of wood finishing. He also demonstrated many examples of different types of finishes on different woods plus additional items to illustrate the points he was making. A truly memorable presentation by a master in the field.

Short business notes. Three thousand dollars in the treasury and eighty eight paid members.

The next meeting is May 26 at 6:30 PM at Woodcraft Supply. The speaker will be John Shrader who will talk about doing metal inlay in wood. I have spoken with Mr. Shrader and visited his website (crestcreations.net) and I am sure this will also be a fine program. Be sure to check out the website.

Thanks again to Don McNutt and George Knutson for their able assistance, and to Ray Ross for bringing the goodies. And again much gratitude to Ron Hall for letting the Guild have its meetings in this great venue.

We will also have a Raffle and Show-and-tell at the next meeting! Be sure to bring your recent projects to share, and your \$\$ to purchase raffle tickets.



A forum for woodworkers of all skill levels to share their common interests

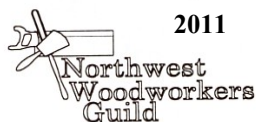

Northwest Woodworkers Guild
Steve Krauss, Newsletter Editor
16204 Main St
Bellevue, WA 98008

Member's Discounts

All members in good standing receive a membership card that will allow them to get a discount at the stores listed below:

Crosscut Hardwoods
4100—1st Avenue S.,
Seattle 98134
10% Discount

Rockler Woodworking
3823 Stone Way N.
Seattle 98103
10% Discount (not valid on power tools)

Woodcraft Supply
5963 Corson S.,
Seattle 98108
10% Discount (not valid on power tools or workbenches)

Edensaw Woods
8032 S. 194th St.
Kent, WA 98032

Please present your current membership card to receive your discount.

Shop Tip (submitted by Herb Stoops)

DRILL BITS PROVIDE GREAT MEASUREMENT

When setting the distance from a router bit to the fence on your router table, a drill bit often can provide you with a more accurate measurement than any ruler in your shop. For example, when you need a $\frac{1}{4}$ " space, simply hold the shank of a $\frac{1}{4}$ " twist-type drill bit against the router bit, as shown at *right*, and move the fence in until the drill bit fits snug against both surfaces.

Don't, however, push the fence in so tight that you can't remove the drill bit. Rather, adjust the fence until the drill bit drags lightly on both the router bit and the fence when you withdraw it (much like using a spark-plug feeler gauge).

You also can employ this technique for setting the height of a router bit. Place a straightedge across the top of the bit, as shown at *right*, and adjust the height of the router bit until the drill bit fits snugly between the router base or tabletop and the straightedge.

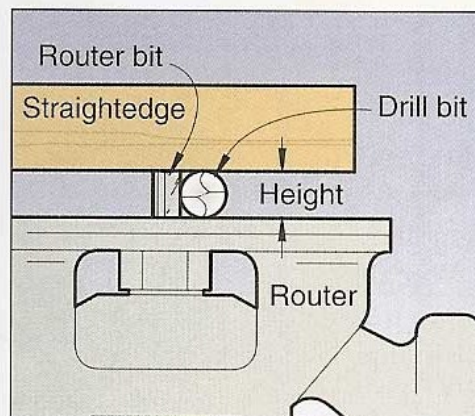
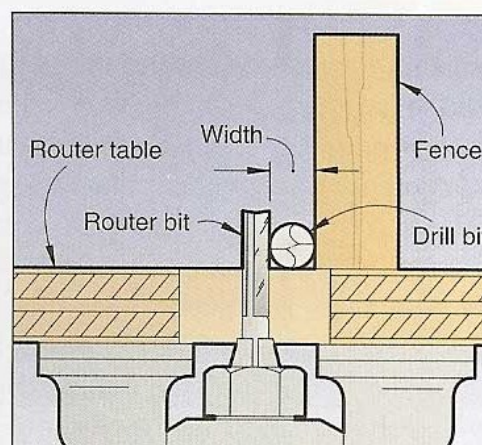

—Ed John, South Sioux City, Ne

April Meeting



April Meeting

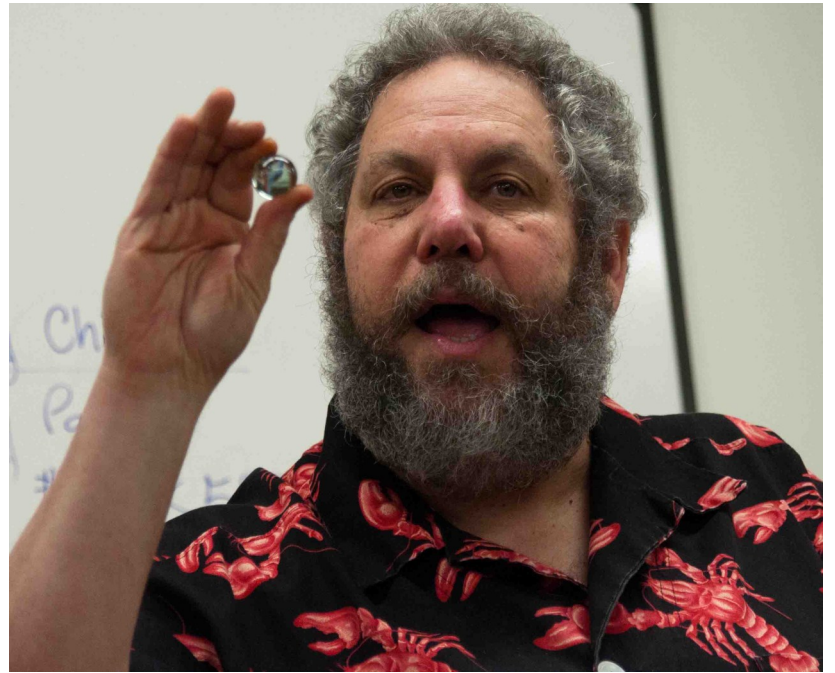
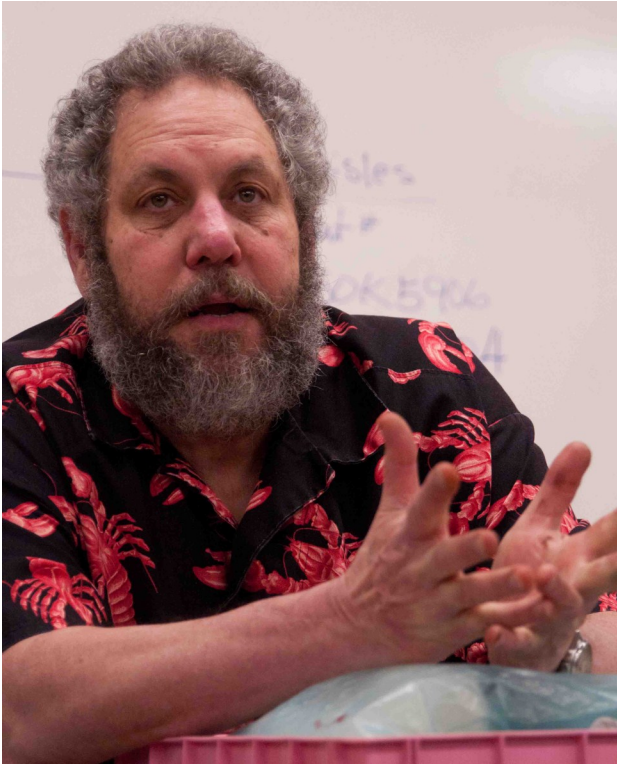

April Meeting



April Meeting



A forum for woodworkers of all skill levels to share their common interests

NORTHWEST WOODWORKERS' GUILD

THE SAWDUST NEWS

May 2011

<http://www.nwwguild.org>

Next Meeting:

Metal Inlay

**By John
Shrader**

**Thursday
May 26, 2011**

► 6:30 PM ◄

**Woodcraft Supply
5963 Corson Ave. S.
Seattle, WA 98108**

Guild Officers

President—Bob Schaefer
**Vice-president and
Membership**—Sally Wright
Treasurer—Chris Green
Secretary—Rick Tydings
Programs—Al Falco, Don
McNutt, Jack Martin, Ed
Moore, Ray Ross
Raffle—Tom Murray, Herb
Stoops

The following are volunteer
positions and are not
Officers of the Guild:

Webmaster
Tom Howorth
thoworth@gmail.com

Newsletter
Steve Krauss
catbert@oz.net
425-746-5067

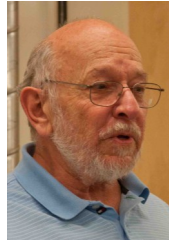

President's Message

— by Bob Schaefer

The April 28 meeting was truly outstanding. Michael Dresdner put on a most informative question and answer program responding to numerous questions with wit, humor and, most importantly, great depth and breadth of knowledge of wood finishing. He also demonstrated many examples of different types of finishes on different woods plus additional items to illustrate the points he was making. A truly memorable presentation by a master in the field.

Short business notes. Three thousand dollars in the treasury and eighty eight paid members.

The next meeting is May 26 at 6:30 PM at Woodcraft Supply. The speaker will be John Shrader who will talk about doing metal inlay in wood. I have spoken with Mr. Shrader and visited his website (crestcreations.net) and I am sure this will also be a fine program. Be sure to check out the website.

Thanks again to Don McNutt and George Knutson for their able assistance, and to Ray Ross for bringing the goodies. And again much gratitude to Ron Hall for letting the Guild have its meetings in this great venue.

We will also have a Raffle and Show-and-tell at the next meeting! Be sure to bring your recent projects to share, and your \$\$ to purchase raffle tickets.



A forum for woodworkers of all skill levels to share their common interests

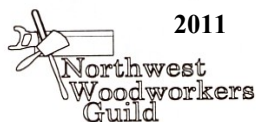

Northwest Woodworkers Guild
Steve Krauss, Newsletter Editor
16204 Main St
Bellevue, WA 98008

Member's Discounts

All members in good standing receive a membership card that will allow them to get a discount at the stores listed below:

Crosscut Hardwoods
4100—1st Avenue S.,
Seattle 98134
10% Discount

Rockler Woodworking
3823 Stone Way N.
Seattle 98103
10% Discount (not valid on power tools)

Woodcraft Supply
5963 Corson S.,
Seattle 98108
10% Discount (not valid on power tools or workbenches)

Edensaw Woods
8032 S. 194th St.
Kent, WA 98032

Please present your current membership card to receive your discount.

Shop Tip (submitted by Herb Stoops)

DRILL BITS PROVIDE GREAT MEASUREMENT

When setting the distance from a router bit to the fence on your router table, a drill bit often can provide you with a more accurate measurement than any ruler in your shop. For example, when you need a $\frac{1}{4}$ " space, simply hold the shank of a $\frac{1}{4}$ " twist-type drill bit against the router bit, as shown at *right*, and move the fence in until the drill bit fits snug against both surfaces.

Don't, however, push the fence in so tight that you can't remove the drill bit. Rather, adjust the fence until the drill bit drags lightly on both the router bit and the fence when you withdraw it (much like using a spark-plug feeler gauge).

You also can employ this technique for setting the height of a router bit. Place a straightedge across the top of the bit, as shown at *right*, and adjust the height of the router bit until the drill bit fits snugly between the router base or tabletop and the straightedge.

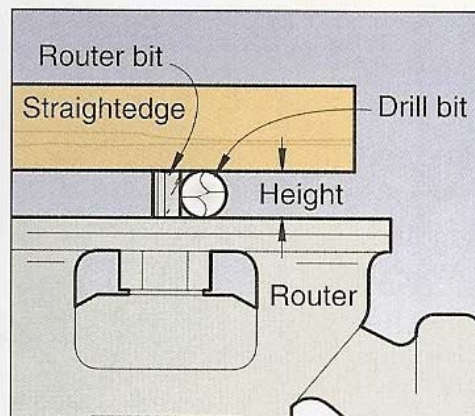
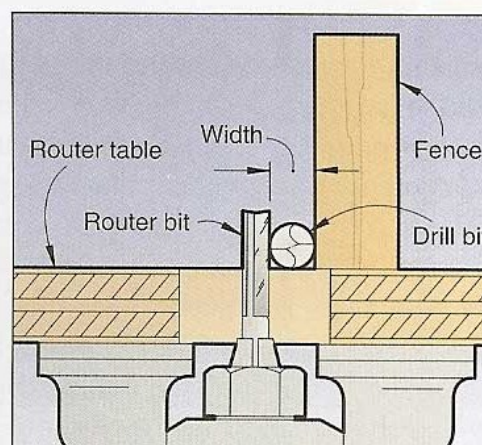

—Ed John, South Sioux City, Ne

April Meeting



April Meeting

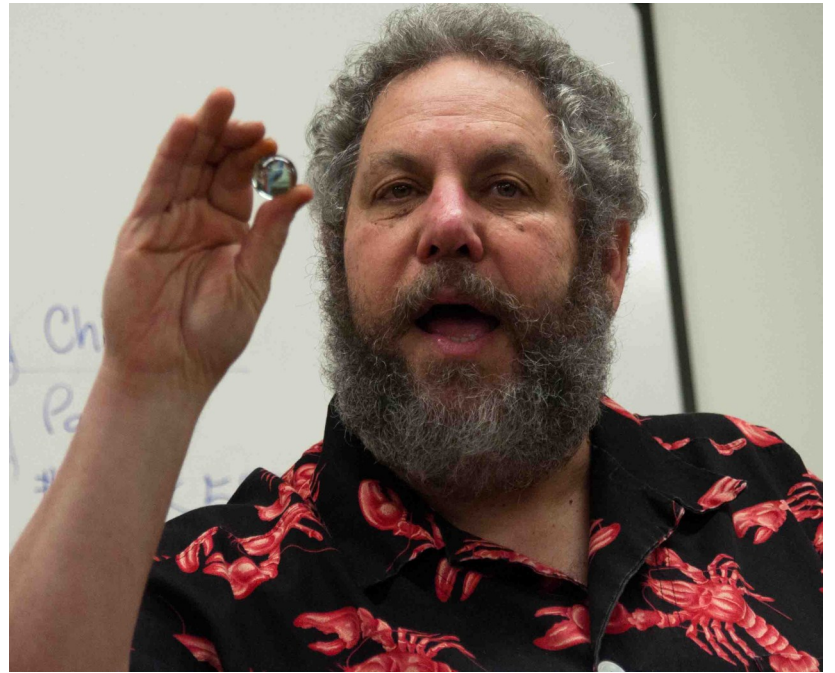
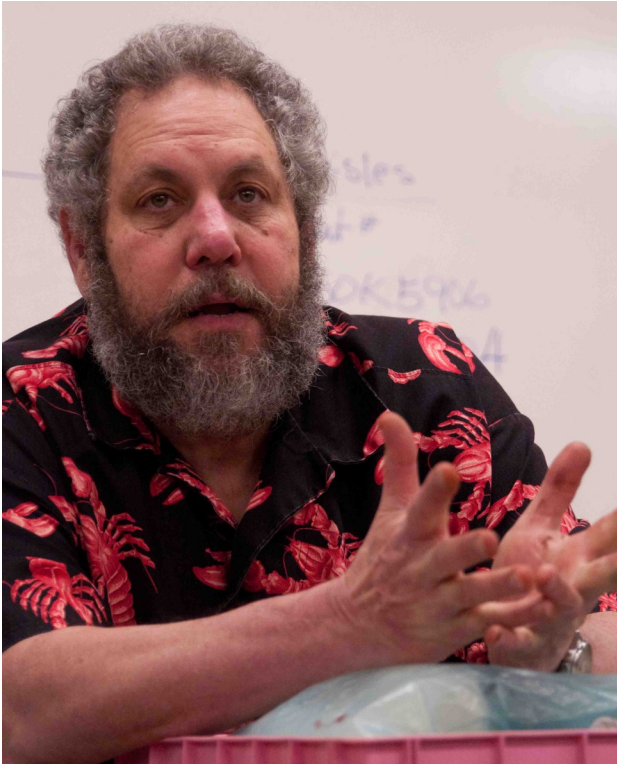

April Meeting



April Meeting



A forum for woodworkers of all skill levels to share their common interests

NORTHWEST WOODWORKERS' GUILD

THE SAWDUST NEWS

May 2011

<http://www.nwwguild.org>

Next Meeting:

Metal Inlay

**By John
Shrader**

**Thursday
May 26, 2011**

► 6:30 PM ◄

**Woodcraft Supply
5963 Corson Ave. S.
Seattle, WA 98108**

Guild Officers

President—Bob Schaefer
**Vice-president and
Membership**—Sally Wright
Treasurer—Chris Green
Secretary—Rick Tydings
Programs—Al Falco, Don
McNutt, Jack Martin, Ed
Moore, Ray Ross
Raffle—Tom Murray, Herb
Stoops

The following are volunteer
positions and are not
Officers of the Guild:

Webmaster
Tom Howorth
thoworth@gmail.com

Newsletter
Steve Krauss
catbert@oz.net
425-746-5067

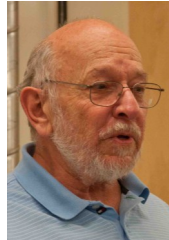

President's Message

— by Bob Schaefer

The April 28 meeting was truly outstanding. Michael Dresdner put on a most informative question and answer program responding to numerous questions with wit, humor and, most importantly, great depth and breadth of knowledge of wood finishing. He also demonstrated many examples of different types of finishes on different woods plus additional items to illustrate the points he was making. A truly memorable presentation by a master in the field.

Short business notes. Three thousand dollars in the treasury and eighty eight paid members.

The next meeting is May 26 at 6:30 PM at Woodcraft Supply. The speaker will be John Shrader who will talk about doing metal inlay in wood. I have spoken with Mr. Shrader and visited his website (crestcreations.net) and I am sure this will also be a fine program. Be sure to check out the website.

Thanks again to Don McNutt and George Knutson for their able assistance, and to Ray Ross for bringing the goodies. And again much gratitude to Ron Hall for letting the Guild have its meetings in this great venue.

We will also have a Raffle and Show-and-tell at the next meeting! Be sure to bring your recent projects to share, and your \$\$ to purchase raffle tickets.



A forum for woodworkers of all skill levels to share their common interests

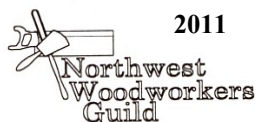

Northwest Woodworkers Guild
Steve Krauss, Newsletter Editor
16204 Main St
Bellevue, WA 98008

Member's Discounts

All members in good standing receive a membership card that will allow them to get a discount at the stores listed below:

Crosscut Hardwoods
4100—1st Avenue S.,
Seattle 98134
10% Discount

Rockler Woodworking
3823 Stone Way N.
Seattle 98103
10% Discount (not valid on power tools)

Woodcraft Supply
5963 Corson S.,
Seattle 98108
10% Discount (not valid on power tools or workbenches)

Edensaw Woods
8032 S. 194th St.
Kent, WA 98032

Please present your current membership card to receive your discount.

Shop Tip (submitted by Herb Stoops)

DRILL BITS PROVIDE GREAT MEASUREMENT

When setting the distance from a router bit to the fence on your router table, a drill bit often can provide you with a more accurate measurement than any ruler in your shop. For example, when you need a $\frac{1}{4}$ " space, simply hold the shank of a $\frac{1}{4}$ " twist-type drill bit against the router bit, as shown at *right*, and move the fence in until the drill bit fits snug against both surfaces.

Don't, however, push the fence in so tight that you can't remove the drill bit. Rather, adjust the fence until the drill bit drags lightly on both the router bit and the fence when you withdraw it (much like using a spark-plug feeler gauge).

You also can employ this technique for setting the height of a router bit. Place a straightedge across the top of the bit, as shown at *right*, and adjust the height of the router bit until the drill bit fits snugly between the router base or tabletop and the straightedge.

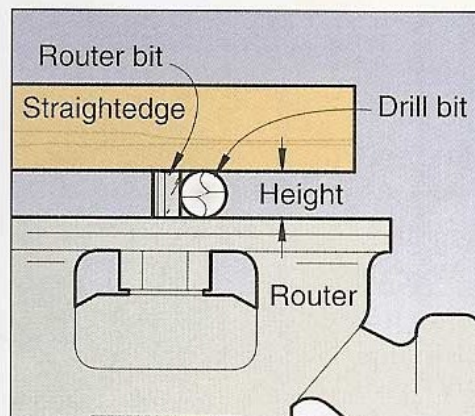
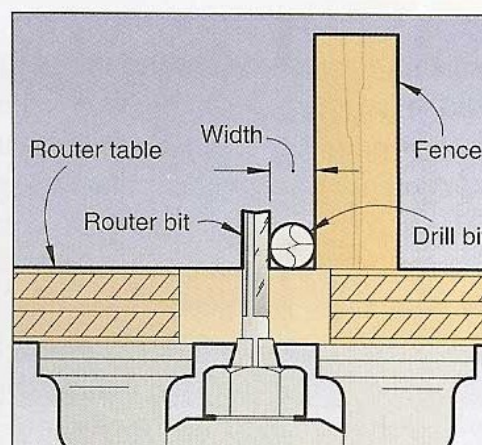

—Ed John, South Sioux City, Ne

April Meeting



April Meeting

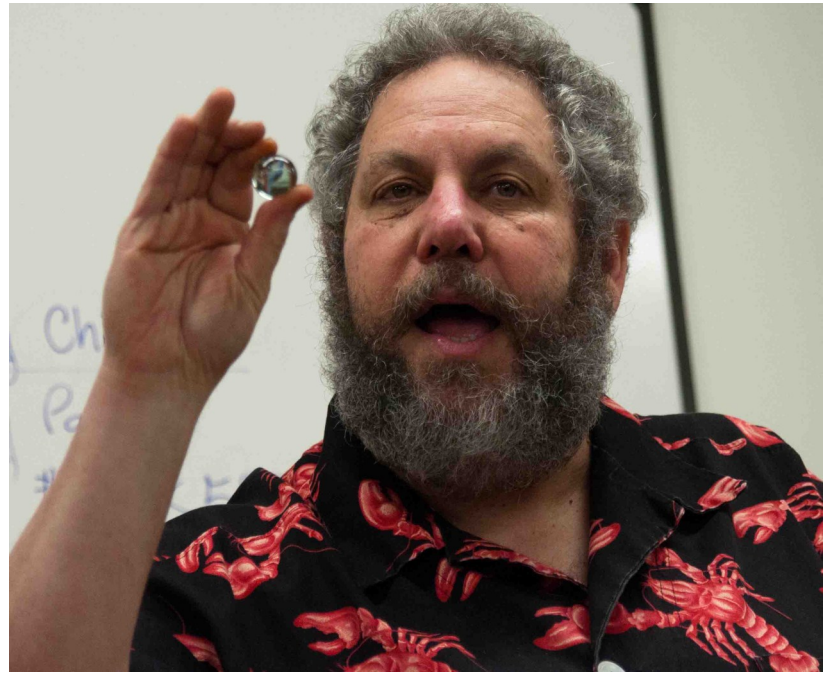
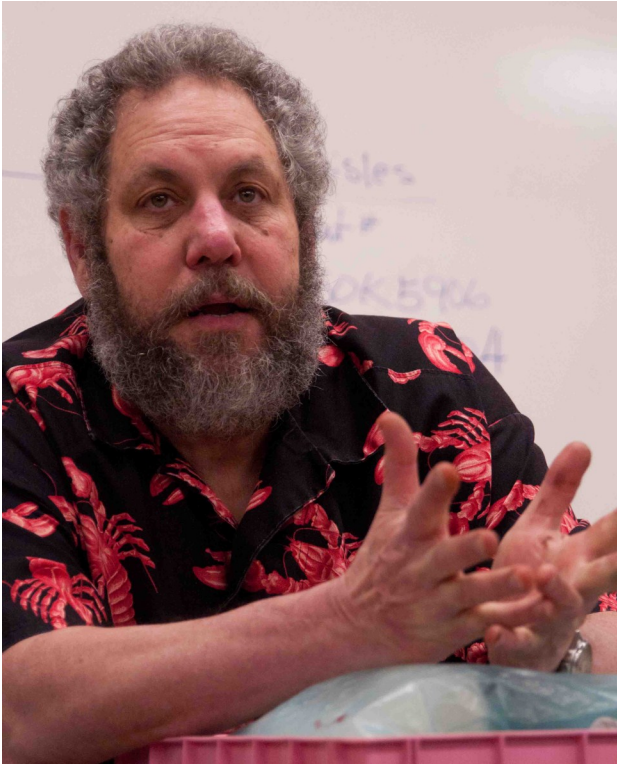

April Meeting



April Meeting



A forum for woodworkers of all skill levels to share their common interests

NORTHWEST WOODWORKERS' GUILD

THE SAWDUST NEWS

May 2011

<http://www.nwwguild.org>

Next Meeting:

Metal Inlay

**By John
Shrader**

**Thursday
May 26, 2011**

► 6:30 PM ◄

**Woodcraft Supply
5963 Corson Ave. S.
Seattle, WA 98108**

Guild Officers

President—Bob Schaefer
**Vice-president and
Membership**—Sally Wright
Treasurer—Chris Green
Secretary—Rick Tydings
Programs—Al Falco, Don
McNutt, Jack Martin, Ed
Moore, Ray Ross
Raffle—Tom Murray, Herb
Stoops

The following are volunteer
positions and are not
Officers of the Guild:

Webmaster
Tom Howorth
thoworth@gmail.com

Newsletter
Steve Krauss
catbert@oz.net
425-746-5067

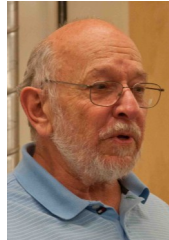

President's Message

— by Bob Schaefer

The April 28 meeting was truly outstanding. Michael Dresdner put on a most informative question and answer program responding to numerous questions with wit, humor and, most importantly, great depth and breadth of knowledge of wood finishing. He also demonstrated many examples of different types of finishes on different woods plus additional items to illustrate the points he was making. A truly memorable presentation by a master in the field.

Short business notes. Three thousand dollars in the treasury and eighty eight paid members.

The next meeting is May 26 at 6:30 PM at Woodcraft Supply. The speaker will be John Shrader who will talk about doing metal inlay in wood. I have spoken with Mr. Shrader and visited his website (crestcreations.net) and I am sure this will also be a fine program. Be sure to check out the website.

Thanks again to Don McNutt and George Knutson for their able assistance, and to Ray Ross for bringing the goodies. And again much gratitude to Ron Hall for letting the Guild have its meetings in this great venue.

We will also have a Raffle and Show-and-tell at the next meeting! Be sure to bring your recent projects to share, and your \$\$ to purchase raffle tickets.



A forum for woodworkers of all skill levels to share their common interests

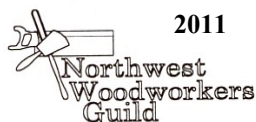

Northwest Woodworkers Guild
Steve Krauss, Newsletter Editor
16204 Main St
Bellevue, WA 98008

Member's Discounts

All members in good standing receive a membership card that will allow them to get a discount at the stores listed below:

Crosscut Hardwoods
4100—1st Avenue S.,
Seattle 98134
10% Discount

Rockler Woodworking
3823 Stone Way N.
Seattle 98103
10% Discount (not valid on power tools)

Woodcraft Supply
5963 Corson S.,
Seattle 98108
10% Discount (not valid on power tools or workbenches)

Edensaw Woods
8032 S. 194th St.
Kent, WA 98032

Please present your current membership card to receive your discount.

Shop Tip (submitted by Herb Stoops)

DRILL BITS PROVIDE GREAT MEASUREMENT

When setting the distance from a router bit to the fence on your router table, a drill bit often can provide you with a more accurate measurement than any ruler in your shop. For example, when you need a $\frac{1}{4}$ " space, simply hold the shank of a $\frac{1}{4}$ " twist-type drill bit against the router bit, as shown at *right*, and move the fence in until the drill bit fits snug against both surfaces.

Don't, however, push the fence in so tight that you can't remove the drill bit. Rather, adjust the fence until the drill bit drags lightly on both the router bit and the fence when you withdraw it (much like using a spark-plug feeler gauge).

You also can employ this technique for setting the height of a router bit. Place a straightedge across the top of the bit, as shown at *right*, and adjust the height of the router bit until the drill bit fits snugly between the router base or tabletop and the straightedge.

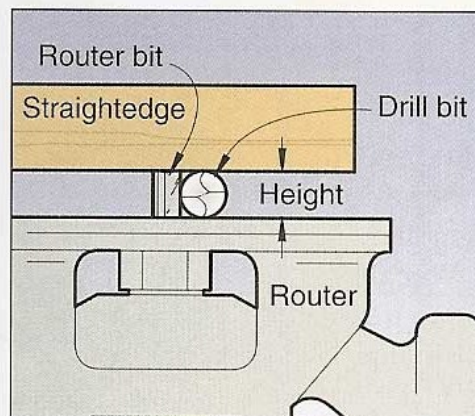
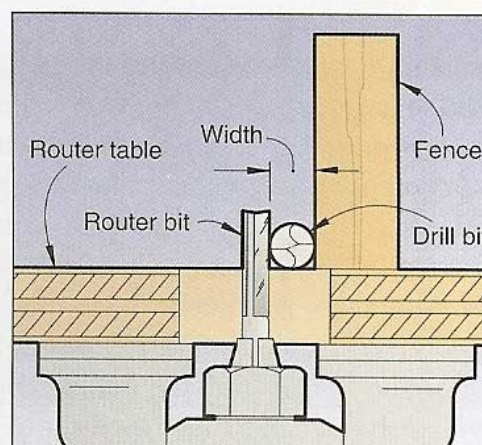

—Ed John, South Sioux City, Ne

April Meeting



April Meeting

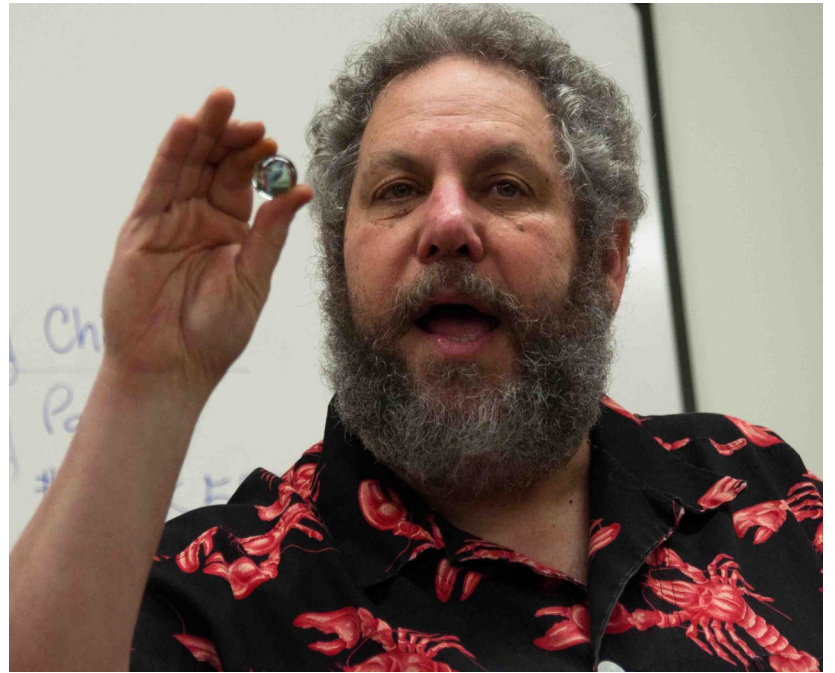
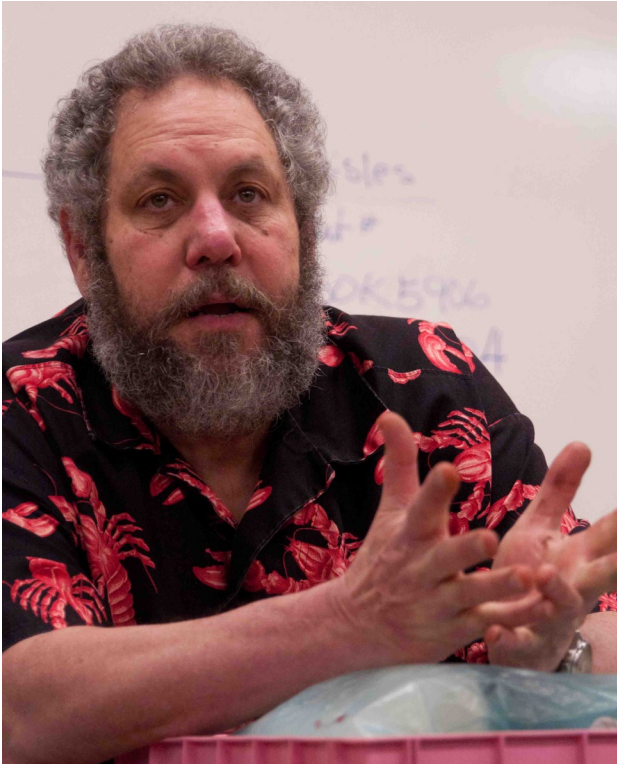

April Meeting



April Meeting



A forum for woodworkers of all skill levels to share their common interests

NORTHWEST WOODWORKERS' GUILD

THE SAWDUST NEWS

May 2011

<http://www.nwwguild.org>

Next Meeting:

Metal Inlay

**By John
Shrader**

**Thursday
May 26, 2011**

► 6:30 PM ◄

**Woodcraft Supply
5963 Corson Ave. S.
Seattle, WA 98108**

Guild Officers

President—Bob Schaefer
**Vice-president and
Membership**—Sally Wright
Treasurer—Chris Green
Secretary—Rick Tydings
Programs—Al Falco, Don
McNutt, Jack Martin, Ed
Moore, Ray Ross
Raffle—Tom Murray, Herb
Stoops

The following are volunteer
positions and are not
Officers of the Guild:

Webmaster
Tom Howorth
thoworth@gmail.com

Newsletter
Steve Krauss
catbert@oz.net
425-746-5067

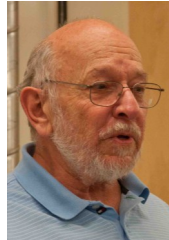

President's Message

— by Bob Schaefer

The April 28 meeting was truly outstanding. Michael Dresdner put on a most informative question and answer program responding to numerous questions with wit, humor and, most importantly, great depth and breadth of knowledge of wood finishing. He also demonstrated many examples of different types of finishes on different woods plus additional items to illustrate the points he was making. A truly memorable presentation by a master in the field.

Short business notes. Three thousand dollars in the treasury and eighty eight paid members.

The next meeting is May 26 at 6:30 PM at Woodcraft Supply. The speaker will be John Shrader who will talk about doing metal inlay in wood. I have spoken with Mr. Shrader and visited his website (crestcreations.net) and I am sure this will also be a fine program. Be sure to check out the website.

Thanks again to Don McNutt and George Knutson for their able assistance, and to Ray Ross for bringing the goodies. And again much gratitude to Ron Hall for letting the Guild have its meetings in this great venue.

We will also have a Raffle and Show-and-tell at the next meeting! Be sure to bring your recent projects to share, and your \$\$ to purchase raffle tickets.



A forum for woodworkers of all skill levels to share their common interests

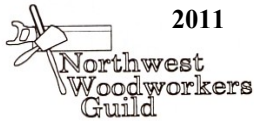

Northwest Woodworkers Guild
Steve Krauss, Newsletter Editor
16204 Main St
Bellevue, WA 98008

Member's Discounts

All members in good standing receive a membership card that will allow them to get a discount at the stores listed below:

Crosscut Hardwoods
4100—1st Avenue S.,
Seattle 98134
10% Discount

Rockler Woodworking
3823 Stone Way N.
Seattle 98103
10% Discount (not valid on power tools)

Woodcraft Supply
5963 Corson S.,
Seattle 98108
10% Discount (not valid on power tools or workbenches)

Edensaw Woods
8032 S. 194th St.
Kent, WA 98032

Please present your current membership card to receive your discount.

Shop Tip (submitted by Herb Stoops)

DRILL BITS PROVIDE GREAT MEASUREMENT

When setting the distance from a router bit to the fence on your router table, a drill bit often can provide you with a more accurate measurement than any ruler in your shop. For example, when you need a $\frac{1}{4}$ " space, simply hold the shank of a $\frac{1}{4}$ " twist-type drill bit against the router bit, as shown at *right*, and move the fence in until the drill bit fits snug against both surfaces.

Don't, however, push the fence in so tight that you can't remove the drill bit. Rather, adjust the fence until the drill bit drags lightly on both the router bit and the fence when you withdraw it (much like using a spark-plug feeler gauge).

You also can employ this technique for setting the height of a router bit. Place a straightedge across the top of the bit, as shown at *right*, and adjust the height of the router bit until the drill bit fits snugly between the router base or tabletop and the straightedge.

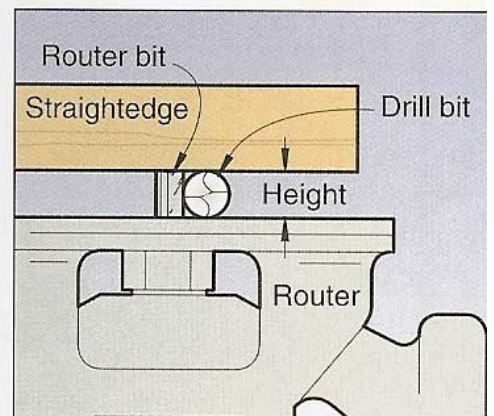
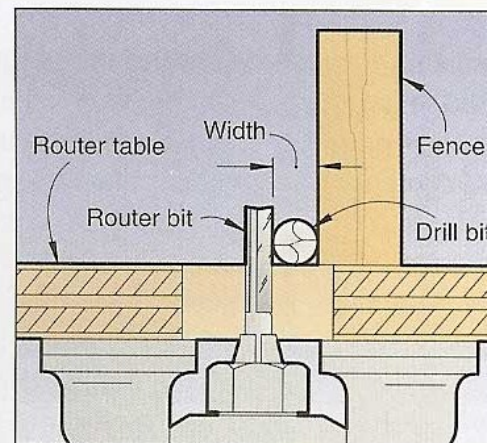

—Ed John, South Sioux City, Ne

April Meeting



April Meeting

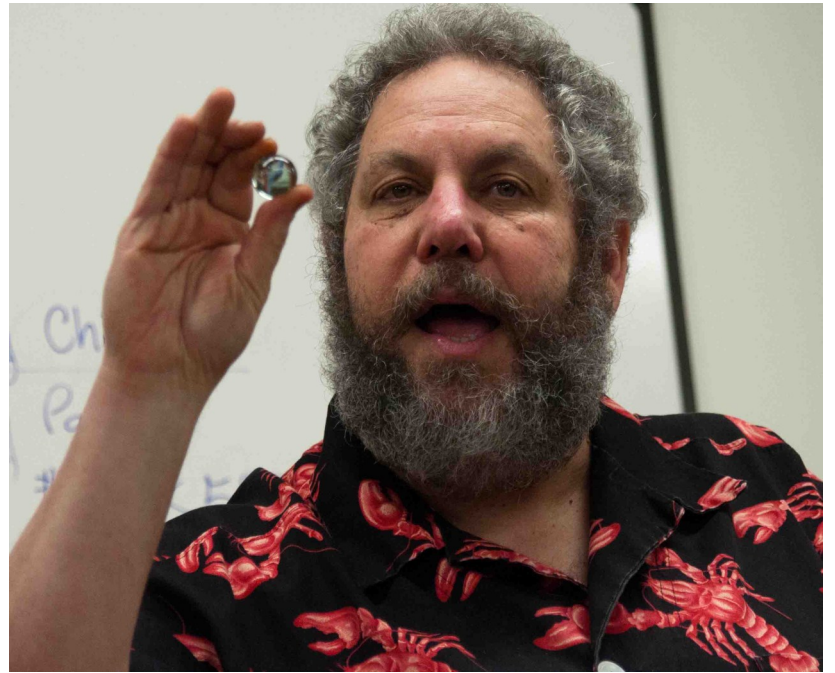
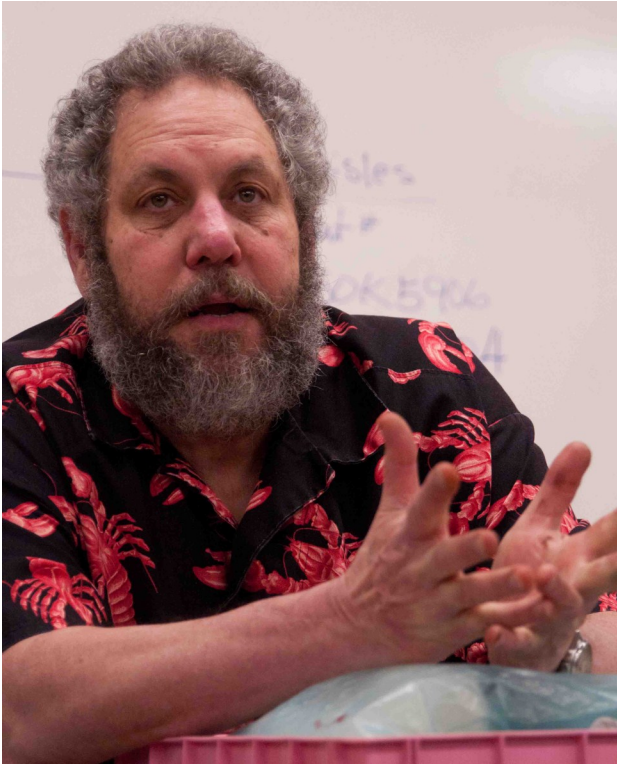

April Meeting



April Meeting

